

ADJ[®]

DOTZ PAR

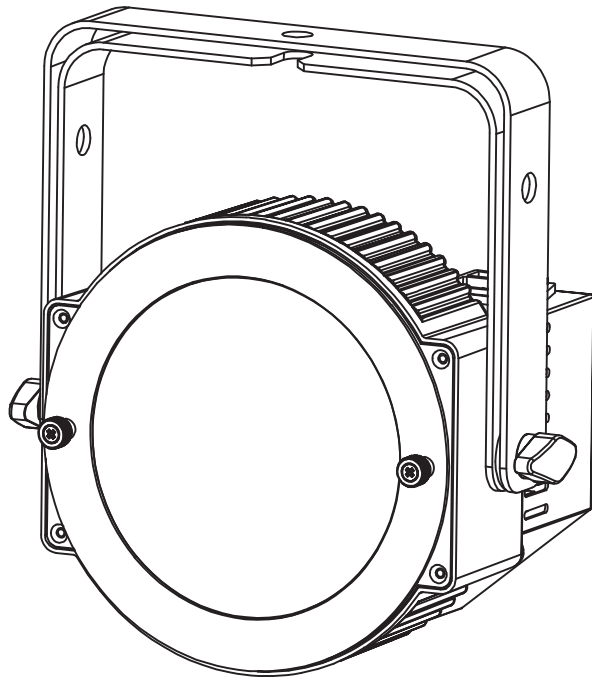

User Instructions



©2014 ADJ Products, LLC all rights reserved. Information, specifications, diagrams, images, and instructions herein are subject to change without notice. ADJ Products, LLC logo and identifying product names and numbers herein are trademarks of ADJ Products, LLC. Copyright protection claimed includes all forms and matters of copyrightable materials and information now allowed by statutory or judicial law or hereinafter granted. Product names used in this document may be trademarks or registered trademarks of their respective companies and are hereby acknowledged. All non-ADJ Products, LLC brands and product names are trademarks or registered trademarks of their respective companies.

ADJ Products, LLC and all affiliated companies hereby disclaim any and all liabilities for property, equipment, building, and electrical damages, injuries to any persons, and direct or indirect economic loss associated with the use or reliance of any information contained within this document, and/or as a result of the improper, unsafe, insufficient and negligent assembly, installation, rigging, and operation of this product.

Europe Energy Saving Notice
Energy Saving Matters (EuP 2009/125/EC)
Saving electric energy is a key to help protecting the environment.
Please turn off all electrical products when they are not in use. To avoid power consumption in idle mode, disconnect all electrical equipment from power when not in use. Thank you!

Dotz Par

Introduction

Unpacking: Thank you for purchasing the Dotz Par by ADJ Products, LLC. Every Dotz Par has been thoroughly tested and has been shipped in perfect operating condition. Carefully check the shipping carton for damage that may have occurred during shipping. If the carton appears to be damaged, carefully inspect your fixture for any damage and be sure all accessories necessary to operate the unit has arrived intact. In the case damage has been found or parts are missing, please contact our toll free customer support number for further instructions. Do not return this unit to your dealer without first contacting customer support.

Introduction: The Dotz Par is part of ADJ's continuing pursuit for creating high quality affordable intelligent fixtures. The Dotz Par is a high performance, DMX intelligent, moving head LED fixture. This fixture is a great piece for retail stores, displays, mood, architectural, interior and exterior decoration, and clubs. This unit can be used as a stand alone, or in a Master/Slave configuration. The unit can also be controlled via DMX controller. This fixture is suitable for theaters, studios, retail stores, and other similar locations.

Customer Support: ADJ Products, LLC provides a toll free customer support line, to provide set up help and to answer any question should you encounter problems during your set up or initial operation. You may also visit us on the web at www.adj.com for any comments or suggestions. Service Hours are Monday through Friday 8:00 a.m. to 4:30 p.m. Pacific Standard Time.

Voice: (800) 322-6337

Fax: (323) 582-2941

E-mail: support@americandj.com

To purchase parts online visit <http://parts.americandj.com>

Warning! To prevent or reduce the risk of electrical shock or fire, do not expose this unit to rain or moisture.

Caution! There are no user serviceable parts inside this unit. Do not attempt any repairs yourself, doing so will void your manufactures warranty. In the unlikely event your unit may require service please contact ADJ Products, LLC.

PLEASE recycle the shipping carton when ever possible.

Dotz Par

General Instructions

To optimize the performance of this product, please read these operating instructions carefully to familiarize yourself with the basic operations of this unit. These instructions contain important safety information regarding the use and maintenance of this unit. Please keep this manual with the unit, for future reference.

Dotz Par

Features

- RGB Color Mixing
- Strobing
- Electronic Dimming 0-100%
- Built in Microphone
- DMX-512 protocol
- Four DMX Modes: 3 Channel Mode, 4 Channel Mode, 5 Channel Mode, & 9 Channel Mode,
- 4 Operating Modes - Sound Active, Auto Run, Built-In Programs, or DMX Control
- Power Cord Daisy Chaining (See Page 21)

Dotz Par

Warranty Registration

The Dotz Par carries a 2 year (730 days) limited warranty. Please fill out the enclosed warranty card to validate your purchase and warranty. You may also register your product online at www.americandj.com. All returned service items whether under warranty or not, must be freight pre-paid and accompany a return authorization (R.A.) number. If the unit is under warranty you must provide a copy of your proof of purchase invoice. Please contact ADJ Products, LLC customer support for a R.A. number.

- To reduce the risk of electrical shock or fire, do not expose this unit rain or moisture
- Do not spill water or other liquids into or on to your unit.
- Be sure that the local power outlet match that of the required voltage for your unit.
- Do not attempt to operate this unit if the power cord has been frayed or broken. Do not attempt to remove or break off the ground prong from the electrical cord. This prong is used to reduce the risk of electrical shock and fire in case of an internal short.
- Disconnect from main power before making any type of connection.
- Do not remove the cover under any conditions. There are no user serviceable parts inside.
- Never operate this unit when it's cover is removed.
- Never plug this unit in to a dimmer pack
- Always be sure to mount this unit in an area that will allow proper ventilation. Allow about 6" (15cm) between this device and a wall.
- Do not attempt to operate this unit, if it becomes damaged.
- This unit is intended for indoor use only, use of this product outdoors voids all warranties.
- During long periods of non-use, disconnect the unit's main power.
- Always mount this unit in safe and stable matter.
- Power-supply cords should be routed so that they are not likely to be walked on or pinched by items placed upon or against them, paying particular attention to the point they exit from the unit.
- Cleaning -The fixture should be cleaned only as recommended by the manufacturer. See page 19 for cleaning details.
- Heat -The appliance should be situated away from heat sources such as radiators, heat registers, stoves, or other appliances (including amplifiers) that produce heat.
- The fixture should be serviced by qualified service personnel when:
 - A. The power-supply cord or the plug has been damaged.
 - B. Objects have fallen, or liquid has been spilled into the appliance.
 - C. The appliance has been exposed to rain or water.
 - D. The appliance does not appear to operate normally or exhibits a marked change in performance.

Power Supply: The ADJ Dotz Par contains a automatic voltage switch, which will auto sense the voltage when it is plugged into a power source. With this switch there is no need to worry about the correct power voltage, this unit can be plugged in anywhere. Always use the PowerCon cord that came with the unit.

DMX-512: DMX is short for Digital Multiplex. This is a universal protocol used as a form of communication between intelligent fixtures and controllers. A DMX controller sends DMX data instructions from the controller to the fixture. DMX data is sent as serial data that travels from fixture to fixture via the DATA "IN" and DATA "OUT" XLR terminals located on all DMX fixtures (most controllers only have a DATA "OUT" terminal).

DMX Linking: DMX is a language allowing all makes and models of different manufactures to be linked together and operate from a single controller, as long as all fixtures and the controller are DMX compliant. To ensure proper DMX data transmission, when using several DMX fixtures try to use the shortest cable path possible. The order in which fixtures are connected in a DMX line does not influence the DMX addressing. For example; a fixture assigned a DMX address of 1 may be placed anywhere in a DMX line, at the beginning, at the end, or anywhere in the middle. When a fixture is assigned a DMX address of 1, the DMX controller knows to send DATA assigned to address 1 to that unit, no matter where it is located in the DMX chain.

Data Cable (DMX Cable) Requirements (For DMX Operation):

The Dotz Par can be controlled via DMX-512 protocol. The Dotz Par has 4 DMX Channel Modes. The DMX address is set on the rear panel of the Dotz Par. Your unit and your DMX controller require a approved DMX-512 110 Ohm Data cable for data input and data output (Figure 1). We recommend Accu-Cable DMX cables. If you are making your own cables, be sure to use standard 110-120 Ohm shielded cable (This cable may be purchased at almost all professional sound and lighting stores). Your cables should be made with a male and female XLR connector on either end of the cable. Also remember that DMX cable must be daisy chained and cannot be split.



Figure 1

Notice: Be sure to follow figures two and three when making your own cables. Do not use the ground lug on the XLR connector. Do not connect the cable's shield conductor to the ground lug or allow the shield conductor to come in contact with the XLR's outer casing. Grounding the shield could cause a short circuit and erratic behavior.

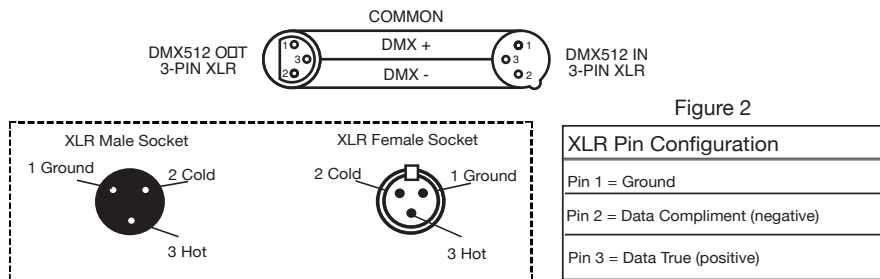

Figure 3

Special Note: Line Termination. When longer runs of cable are used, you may need to use a terminator on the last unit to avoid erratic behavior. A terminator is a 90-120 ohm 1/4 watt resistor which is connected between pins 2 and 3 of a male XLR connector (DATA + and DATA -). This unit is inserted in the female XLR connector of the last unit in your daisy chain to terminate the line. Using a cable terminator (ADJ part number Z-DMX/T) will decrease the possibilities of erratic behavior.

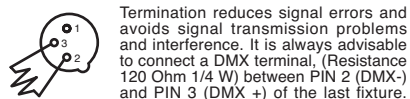

Figure 4

5-Pin XLR DMX Connectors. Some manufactures use 5-pin XLR connectors for DATA transmission in place of 3-pin. 5-pin XLR fixtures may be implemented in a 3-pin XLR DMX line. When inserting standard 5-pin XLR connectors in to a 3-pin line a cable adaptor must be used, these adaptors are readily available at most electric stores. The chart below details a proper cable conversion.

3-Pin XLR to 5-Pin XLR Conversion		
Conductor	3-Pin XLR Female (Out)	5-Pin XLR Male (In)
Ground/Shield	Pin 1	Pin 1
Data Compliment (- signal)	Pin 2	Pin 2
Data True (+ signal)	Pin 3	Pin 3
Not Used		Do Not Use
Not Used		Do Not Use

The LCD backlight will shut off after 30 seconds, to relight the background, press the MODE button for 5 seconds.

DMX Mode - Set the DMX Address and DMX Channel Mode -

1. Press the MODE button until “AXXX” is displayed. “XXX” represents the current displayed address.
2. Use the UP or DOWN buttons to change the DMX address.
3. After setting your DMX address press ENTER. You can now select your desired DMX channel mode. Use the UP or DOWN buttons to find your desired DMX channel mode, press ENTER when you find your desired DMX channel mode.
4. After you press ENTER you can now set your dimmer curve. There are 5 dimmer curve settings. See Dimmer Curve below for the different curves. Select you desired dimmer curve setting, and press ENTER.
5. After you press ENTER you can set your NO DMX setting. This setting is a precaution setting. This setting is in case you DMX signal is lost or interrupted. See NO DMX on page 9 for the different settings. Press ENTER when you are finished to return to the DMX address setting.

Dimmer Curve - This setting will let you select your desired dimmer curve.

1. Press the MODE button until “AXXX” is displayed. “XXX” represents the current displayed address.
2. Press the SET UP button until “dcXX” is displayed, press ENTER.
3. 1 of 5 dimming curve settings will be displayed: Standard, Stage, TV, Architectural, or Theatre. Use the UP and DOWM buttons to select your desired dimming curve and press ENTER to

confirm.

NO DMX - This mode can be used as a precaution mode, that in case the DMX signal is lost, interrupted, or power is lost, the operating mode chosen in the setup is the running mode the fixture will go into when the DMX signal is lost. You can also set this as the operating mode you would like the unit to return to when power is applied.

1. Press the MENU button until “NO DMX” is displayed, and either “Sound”, “Black”, or “Hold” will be displayed beneath.

2. Press ENTER and the bottom choice will begin to flash. Use the UP or DOWN buttons to choose an operating mode you would like the unit to start up in when power is applied or the DMX signal is lost.

- Sound - If the DMX signal is lost, interrupted, the unit will automatically go into sound active mode.

- Black (Blackout) - If the DMX signal is lost or interrupted, the unit will automatically go into stand by mode.

- Hold - If the DMX signal is lost the fixture will stay in the last DMX setting. If power is applied and this mode is set, the unit will automatically go into the last DMX set up.

3. Press ENTER to confirm your desired set up.

Slave Mode - This will let you set your unit as a slave in a master/slave configuration.

1. Press the MODE button until “SLAU” is displayed. Your unit will now follow the Master.

RGB Dimmer Mode - Select your desired color to remain static or adjust the RGB colors to create your desired

color.

1. Plug the fixture in and press the MODE button until “Manual Dimmer” is displayed, and press ENTER.

2. When “r.XXX” is displayed you are in Red dimming mode. Press the UP and DOWN buttons to adjust intensity.

3. When “G.XXX” is displayed you are in Green dimming mode. Press the UP and DOWN buttons to adjust intensity.

4. When “b.XXX” is displayed you are in Blue dimming mode. Press the UP and DOWN buttons to adjust intensity.

Color Macro - Select your desired color macro to remain static.

1. Press the MODE button until “C-XX” is displayed. “XX” represents the current displayed macro number.

2. Use the UP and DOWN button to scroll through the 32 color macros until you find your desired color.

Built-In Programs - Select your desired Built-In program.

1. Press the MODE button until “P-XX” is displayed. “XX” represents the current displayed program number. Use the UP and DOWN buttons to scroll through 7 different programs.

2. Press ENTER to move through the various adjustments of each program, and use the UP and DOWN buttons to make adjustments.

Sound Mode - In this mode the unit will run in sound active mode.

1. Press the MODE button until “Sound Mode” is displayed.

2. Use the UP and DOWN buttons to adjust the sound sensitivity. “0” being the least sensitive, and “30” being the most.

RF Active - This menu will let you activate the RF remote control.

1. Press the MODE button until “RFXX” is displayed, press ENTER. “XX” represents the current setting, either “on” or “off”
2. Use the UP or DOWN buttons to activate (On) or deactivate (Off) the remote

Universal DMX Control: This function allows you to use a Elation® universal DMX-512 controller to control the chases and patterns, dimmer and strobe. A DMX controller allows you to create unique programs tailored to your individual needs. The Dotz Par has 4 DMX channel modes; a 3 Channel Mode, 4 Channel Mode, 5 Channel Mode, & 9 Channel Mode. See pages 13-16 for the DMX channel modes and traits.

1. This function will allow you to control each individual fixture’s traits with a standard DMX 512 controller such as the Elation® Show Designer™ or the Elation® DMX Operator.™
2. To run your fixture in DMX mode, follow directions on page 7 to set your DMX address and DMX Channel mode.
3. Plug in the fixture via the XLR connections to any standard DMX controller.
4. For longer cable runs (more than a 100 feet) use a terminator on the last fixture.

Master-Slave Operation: This function will allow you to link up to 16 units together and operate without a controller. The units will be sound activated. In Master-Slave operation one unit will act as the controlling unit and the others will react to the controlling units programs. Any unit can act as a Master or as a Slave.

1. Using approved DMX data cables, daisy chain your units together via the XLR connector on the rear of the units. Remember the Male XLR connector is the input and the Female XLR connector is the output. The first unit in the chain (master) will use the female XLR connector only - The last unit in the chain will use the male XLR connector only. For longer cable runs we suggest a terminator at the last fixture.
2. On the Master unit, set your desired operating mode.
3. On the slave units press the MODE button until “Slav” is displayed.
4. The slave units will now follow the Master unit.

Dotz Par**Dotz Par RF Remote**

The Dotz Par RF remote has many different functions and allows you to control your Dotz Par from long distance. The remote can control your system up to 25 meters. To use the remote you must first activate the fixtures receiver, to activate the receiver please see the instructions on page 10.

BLACKOUT - Pressing this button will blackout the fixture.

FADE - This button will activate the color fade program.

COLOR - This button will activate the static color mode. Use the “+” and “-” buttons to scroll through the colors and find your desired color.

PROGRAMS - This button will activate the built-in programs mode. Use the “+” and “-” buttons to scroll through the 13 programs and find your desired program.

SOUND ACTIVE - This button activates sound active mode.

AUTO RUN - This button will run an automatic program. Use the “+” and “-” buttons to adjust the speed of the auto run.

“+” and “-” - Use these buttons to adjust the speed of the Auto Run, scroll through the built-in programs, and scroll through the static colors.

Dotz Par**3 Channel Mode**

Channel	Value	Function
1	0 - 255	RED 0% - 100%
2	0 - 255	GREEN 0% - 100%
3	0 - 255	BLUE 0% - 100%

Dotz Par**4 Channel Mode**

Channel	Value	Function
1	0 - 255	RED 0% - 100%
2	0 - 255	GREEN 0% - 100%
3	0 - 255	BLUE 0% - 100%
4	0 - 255	MASTER DIMMER 0% - 100%

Dotz Par**5 Channel Mode**

Channel	Value	Function
1	0 - 255	RED 0% - 100%
2	0 - 255	GREEN 0% - 100%
3	0 - 255	BLUE 0% - 100%
4	0 - 255	MASTER DIMMER 0% - 100%
5	0 - 41 42 - 84 85 - 127 128 - 170 171 - 213 214 - 255	DIMMER CURVES STANDARD STAGE TV ARCHITECTURAL THEATRE DEFAULT TO UNIT CURVE SETTING

Dotz Par		9 Channel Mode
Channel	Value	Function
1	0 - 255	RED 0% - 100%
2	0 - 255	GREEN 0% - 100%
3	0 - 255	BLUE 0% - 100%
4	0 - 255	MASTER DIMMER 0% - 100%
5	0	COLOR MACROS OFF
	1 - 7	BASTARD AMBER
	8 - 15	MEDIUM AMBER
	16 - 23	PALE AMBER GOLD
	24 - 31	GALLO GOLD
	32 - 39	GOLDEN AMBER
	40 - 47	LIGHT RED
	48 - 55	MEDIUM RED
	56 - 63	MEDIUM PINK
	64 - 71	BROADWAY PINK
	72 - 79	FOLLIES PINK
	80 - 87	LIGHT LAVENDER
	88 - 95	SPECIAL LAVENDER
	96 - 103	LAVENDER
	104 - 111	INDIGO
	112 - 119	HEMSLEY BLUE
	120 - 127	TIPTON BLUE
	128 - 135	LIGHT STEEL BLUE
	136 - 143	LIGHT SKY BLUE
	144 - 151	SKY BLUE
	152 - 159	BRILLIANT BLUE
	160 - 167	LIGHT GREEN BLUE
	168 - 175	BRIGHT BLUE
	176 - 183	PRIMARY BLUE
	184 - 191	CONGO BLUE
	192 - 199	PALE YELLOW GREEN

Dotz Par		9 Channel Mode
Channel	Value	Function
5	200 - 207 208 - 215 216 - 223 224 - 231 232 - 239 240 - 247 248 - 255	COLOR MACROS CONT. MOSS GREEN PRIMARY GREEN DOUBLE CTB FULL RED FULL GREEN FULL BLUE WHITE
6	0 1 - 20 21 - 40 41 - 60 61 - 80 81 - 100 101 - 120 121 - 140 141 - 255	PROGRAMS OFF COLOR FADE/CHANGE 7 COLOR CHANGE 7 COLOR FADE 3 COLOR CHANGE 3 COLOR FADE SOUND ACTIVE COLOR FADE SOUND ACTIVE COLOR CHANGE NOTHING
7	0 - 255 0 - 255	PROGRAM SPEED/SOUND SENSITIVE PROGRAM SPEED SLOW - FAST LEAST SENSITIVE - MOST SENSITIVE
8	1 - 255	STROBING SLOW - FAST
9	0 - 41 42 - 84 85 - 127 128 - 170 171 - 213 214 - 255	DIMMER CURVES STANDARD STAGE TV ARCHITECTURAL THEATRE DEFAULT TO UNIT CURVE SETTING

When Channel 5 is being used Channels 1 - 3 will not function.

When Channel 6 is between the values of 1-100, Channel 7 will control the program speed.

When Channel 6 is between the values of 101-140, Channel 7 will control the sound sensitive.

COLOR	RED	GREEN	BLUE
BASTARD AMBER	255	206	143
MEDIUM AMBER	254	177	153
PALE AMBER GOLD	254	192	138
GALLO GOLD	254	165	98
GOLDEN AMBER	254	121	0
LIGHT RED	176	17	0
MEDIUM RED	96	0	11
MEDIUM PINK	234	139	171
BROADWAY PINK	224	5	97
FOLLIES PINK	175	77	173
LIGHT LAVENDER	119	130	199
SPECIAL LAVENDER	147	164	212
LAVENDER	88	2	163
INDIGO	0	38	86
HEMSLEY BLUE	0	142	208
TIPTON BLUE	52	148	209
LIGHT STEEL BLUE	1	134	201
LIGHT SKY BLUE	0	145	212
SKY BLUE	0	121	192
BRILLIANT BLUE	0	129	184
LIGHT GREEN BLUE	0	83	115
BRIGHT BLUE	0	97	166
PRIMARY BLUE	1	100	167
CONGO BLUE	0	40	86
PALE YELLOW GREEN	209	219	182
MOSS GREEN	42	165	85
PRIMARY GREEN	0	46	35
DOUBLE CTB	8	107	222
FULL RED	255	0	0
FULL GREEN	0	255	0
FULL BLUE	0	0	255
WHITE	255	255	255

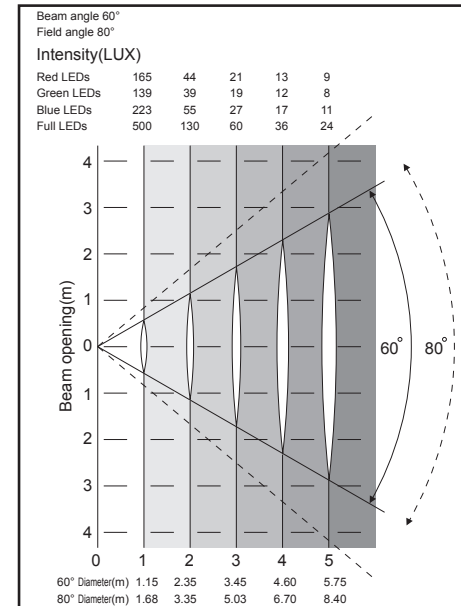

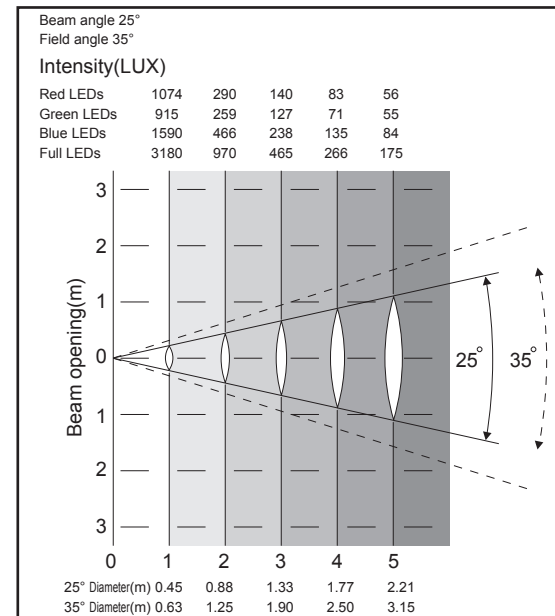

Lens Off

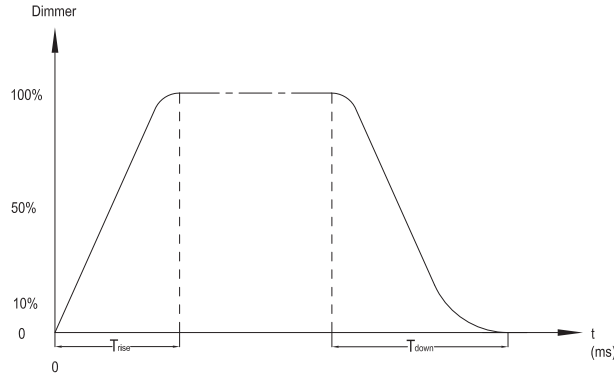

Lens On



Ramp Effect	0  255 OS (Fade Time)		0  255 1S (Fade Time)	
	T _{rise} (ms)	T _{down} (ms)	T _{rise} (ms)	T _{down} (ms)
Standard	0	0	0	0
Stage	780	1100	1540	1660
TV	1180	1520	1860	1940
Architectural	1380	1730	2040	2120
Theatre	1580	1940	2230	2280

With this feature you can connect the fixtures to one another using the IEC input and output sockets. The quantity that can be connected is 10 fixtures maximum for 120V, and 22 fixtures maximum for 230V. After the maximum fixtures has been reached you will need to use a new power outlet. They must be the same fixtures. DO NOT mix fixtures.

Locate and remove the unit’s power cord. Once the cord has been removed locate the fuse holder located inside the power socket. Insert a flat-head screw driver into the power socket and gently pry out the fuse holder. Remove the bad fuse and replace with a new one. The fuse holder has a built-in socket for a spare fuse be sure not to confuse the spare fuse with active fuse.

Due to fog residue, smoke, and dust cleaning the internal and external optical lenses must be carried out periodically to optimize light output.

1. Use a soft cloth to wipe down the outside casing.

Cleaning frequency depends on the environment in which the fixture operates (i.e. smoke, fog residue, dust, dew).

Listed below are a few common problems the user may encounter, with solutions.

Unit not responding to DMX:

1. Check that the DMX cables are connected properly and are wired correctly (pin 3 is “hot”; on some other DMX devices pin 2 may be ‘hot’). Also, check that all cables are connected to the right connectors; it does matter which way the inputs and outputs are connected.

Unit does not respond to sound:

1. Quiet or high pitched sounds will not activate the unit.

If problems are not resolved; Contact ADJ Products, LLC for service. 1-800-322-6337

MANUFACTURER'S LIMITED WARRANTY

- A. ADJ Products, LLC hereby warrants, to the original purchaser, ADJ Products, LLC products to be free of manufacturing defects in material and workmanship for a prescribed period from the date of purchase (see specific warranty period on reverse). This warranty shall be valid only if the product is purchased within the United States of America, including possessions and territories. It is the owner's responsibility to establish the date and place of purchase by acceptable evidence, at the time service is sought.
- B. **For warranty service you must obtain a Return Authorization number (RA#) before sending back the product—please contact ADJ Products, LLC Service Department at 800-322-6337.** Send the product only to the ADJ Products, LLC factory. All shipping charges must be pre-paid. If the requested repairs or service (including parts replacement) are within the terms of this warranty, ADJ Products, LLC will pay return shipping charges only to a designated point within the United States. If the entire instrument is sent, it must be shipped in its original package. No accessories should be shipped with the product. If any accessories are shipped with the product, ADJ Products, LLC shall have no liability whatsoever for loss of or damage to any such accessories, nor for the safe return thereof.
- C. This warranty is void if the serial number has been altered or removed; if the product is modified in any manner which ADJ Products, LLC concludes, after inspection, affects the reliability of the product; if the product has been repaired or serviced by anyone other than the ADJ Products, LLC factory unless prior written authorization was issued to purchaser by ADJ Products, LLC; if the product is damaged because not properly maintained as set forth in the instruction manual.
- D. This is not a service contract, and this warranty does not include maintenance, cleaning or periodic check up. During the period specified above, ADJ Products, LLC will replace defective parts at its expense with new or refurbished parts, and will absorb all expenses for warranty service and repair labor by reason of defects in material or workmanship. The sole responsibility of ADJ Products, LLC under this warranty shall be limited to the repair of the product, or replacement thereof, including parts, at the sole discretion of ADJ Products, LLC. All products covered by this warranty were manufactured after August 15, 2012, and bear indentifying marks to that effect.
- E. ADJ Products, LLC reserves the right to make changes in design and/or improvements upon its products without any obligation to include these changes in any products theretofore manufactured.

No warranty, whether expressed or implied, is given or made with respect to any accessory supplied with products described above. Except to the extent prohibited by applicable law, all implied warranties made by ADJ Products, LLC in connection with this product, including warranties of merchantability or fitness, are limited in duration to the warranty period set forth above. And no warranties, whether expressed or implied, including warranties of merchantability or fitness, shall apply to this product after said period has expired. The consumer's and/or Dealer's sole remedy shall be such repair or replacement as is expressly provided above; and under no circumstances shall ADJ Products, LLC be liable for any loss or damage, direct or consequential, arising out of the use of, or inability to use, this product.

This warranty is the only written warranty applicable to ADJ Products, LLC Products and supersedes all prior warranties and written descriptions of warranty terms and conditions heretofore published.

MANUFACTURER'S LIMITED WARRANTY PERIODS:

- **Lighting Products = 1-year (365 days) Limited Warranty** (Such as: Special Effect Lighting, Intelligent Lighting, UV lighting, Strobes, Fog Machines, Bubble Machines, Mirror Balls, Par Cans, Trussing, Lighting Stands etc. excluding LED and lamps)
- **Laser Products = 90-Day Limited Warranty**
- **L.E.D. Products = 2-year (730 days) Limited Warranty** (excluding motors, PCB boards, and power supplies, which have a 1-year (365 day Limited Warranty) and batteries which have a 180 day limited warranty).

SPECIFICATIONS:

Voltage:	100V~240V 50Hz/60Hz
LEDs:	1 x 36W COB TRI LEDs
Power Draw:	36W
Beam Angle:	25 Degrees 60 Degrees (w/o Lens Cover)
Fuse:	2Amp (125V) 1Amp (250V)
Power Cord Daisy Chain:	13 Fixtures Max. (120V) 28 Fixtures Max. (230V)
Weight:	5lbs./ 2Kgs.
Dimensions:	6.5" (L) x 4.5" (W) x 6.5" (H) 165 x 114 x 165mm (W/O Bracket) 8.25" (L) x 4.5" (W) x 8.75" (H) 209 x 114 x 222mm (With Bracket)
Colors:	RGB Color Mixing
DMX Channels:	4 DMX Modes: 3 Channel Mode, 4 Channel Mode, 5 Channel Mode, & 9 Channel Mode
Working Position:	Any safe working position
Warranty:	2 Year (730 days)

Auto Sensing Voltage: *This fixture contains a automatic voltage switch, which will auto sense the voltage when it is plugged into the power source.*

Please Note: Specifications and improvements in the design of this unit and this manual are subject to change without any prior written notice.

ADJ Products, LLC
6122 S. Eastern Ave. Los Angeles, CA 90040 USA
Tel: 323-582-2650 / Fax: 323-725-6100
Web: www.adj.com / E-mail: info@americandj.com

A.D.J. Supply Europe B.V.
Junostraat 2
6468 EW Kerkrade
Netherlands

Follow Us On:



facebook.com/americandj
twitter.com/americandj
youtube.com/adjlighting

service@adjgroup.eu / www.adj.eu
Tel: +31 45 546 85 00 / Fax: +31 45 546 85 99